

TERRENO/PROJETO	1123,53	1123,09	1124,10	1124,75	1125,45	1126,29	1127,06	1127,67	1128,51	1129,35	1129,99	1130,82	1131,54	1132,72	1133,33	1134,19	1135,07	1135,84	1136,80	1137,63	1138,93	1139,54	1140,10	1140,398	1140,66	1141,275	1141,95	1142,303	1143,72	1144,63	1145,156	1145,91	1146,331	1147,582	1148,48	1148,792	1149,72			
QUILOMETRAGEM	0					0+100							0+200												0+500															0+700
PLANIMETRIA	TANGENTE L=284,248																																	PCE			R=1140,000			

**ASTEC Engenharia S/C Ltda.**

ESCALA GRÁFICA: 0 5 10 15 20 25 30 40 50 75 100

FIRMA PROJETAISTA: Nº \_\_\_\_\_ REVISÕES: \_\_\_\_\_

DATA VISTO: \_\_\_\_\_ DATA APROVO: \_\_\_\_\_

CONTRATADA: DER-DF

**GDF - SO - DEPARTAMENTO DE ESTRADAS DE RODAGEM DO DISTRITO FEDERAL**

TÍTULO/ESPECIFICAÇÃO DO DOCUMENTO: DF-220 PLANTA

ETAPA DE PROJETO: EXECUTIVO LOCAL: DF-220 PROJETO: Km 0 AO Km 15,9

ESCALA: A1 - H=1:1000 V=1:100 RECHÃO/SUBRECHÃO: CÁLCULO

FOLHA: 001/023 ESPECIFICAÇÃO/SUBESPECIFICAÇÃO: DRENAGEM SUPERFICIAL DESENHO

REVISÃO: 0 CÓDIGO: DATA: AGOSTO/2004

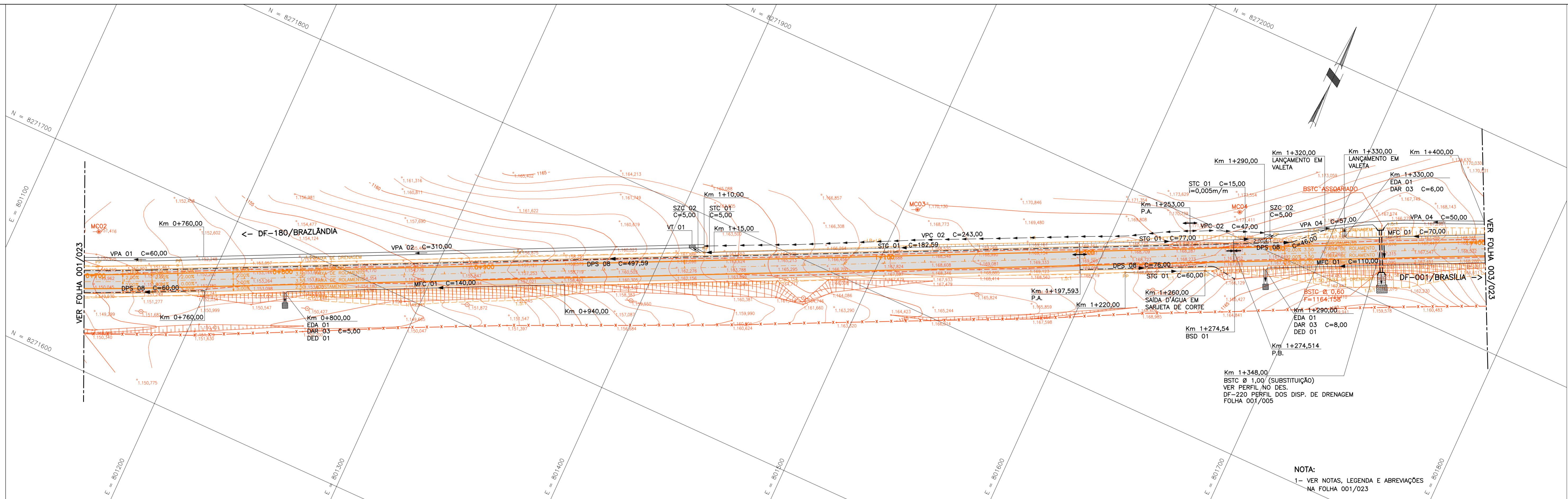

NOTA:  
1- VER NOTAS, LEGENDA E ABREVIACOES NA FOLHA 001/023

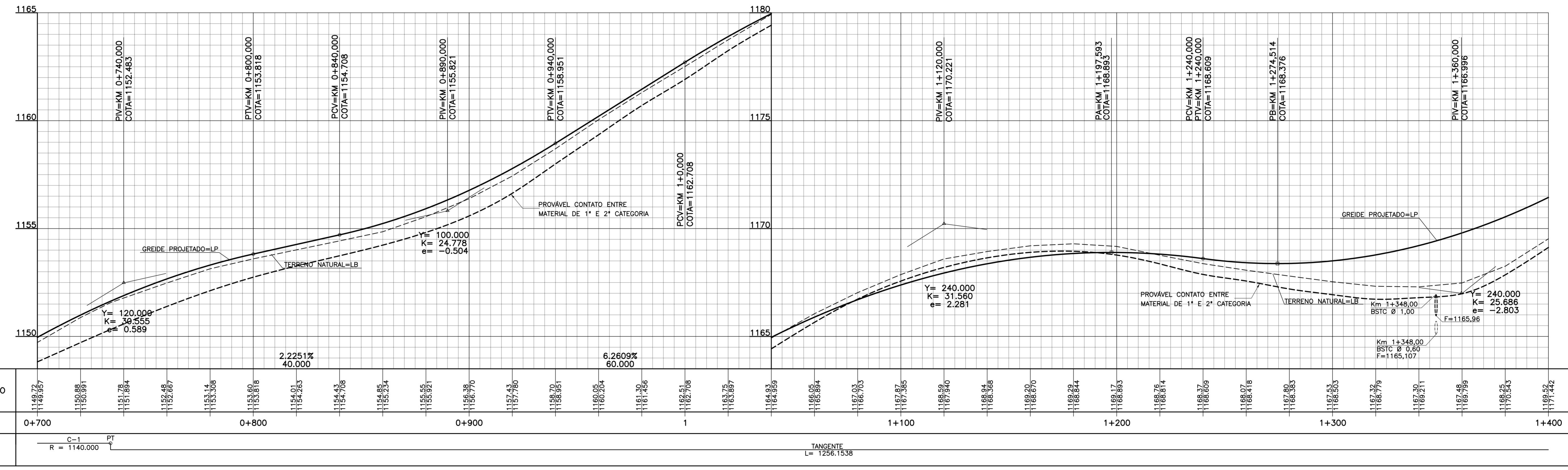

TERRENO/PROJETO	1148,72	1150,88	1151,78	1152,48	1153,14	1153,60	1154,01	1154,43	1155,55	1156,35	1157,43	1158,70	1160,05	1161,30	1162,51	1163,75	1167,03	1167,87	1168,94	1169,20	1169,44	1169,17	1168,75	1168,609	1168,07	1167,32	1167,30	1167,45	1168,25	1169,52	
QUILOMETRAGEM	0+700					0+800									1															1+400	
PLANIMETRIA	C-1 R = 1140,000		PT																												

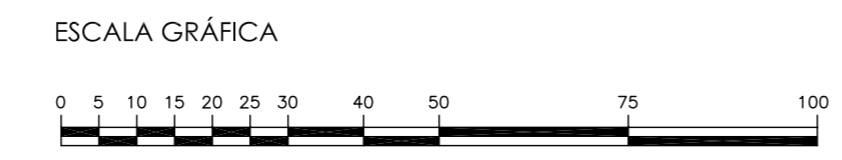

**ASTEC**  
Engenharia S/C Ltda.

FIRMA PROJETISTA Nº REVISÕES

DATA VISTO DATA APROVO  
CONTRATADA DER-DF

GDF - SO - DEPARTAMENTO DE ESTRADAS DE RODAGEM DO DISTRITO FEDERAL

TÍTULO/ESPECIFICAÇÃO DO DOCUMENTO  
DF-220 PLANTA

ETAPA DE PROJETO EXECUTIVO LOCAL DF-220

ESCALA A1 - H=1:1000 V=1:100 RECHO/SUBRECHO Km 0 AO Km 15,9 CÁLCULO

FOLHA 002/023 ESPECIFICIDADE/SUBESPECIFICIDADE DRENAGEM SUPERFICIAL DESENHO

REVISÃO 0 CÓDIGO DATA AGOSTO/2004







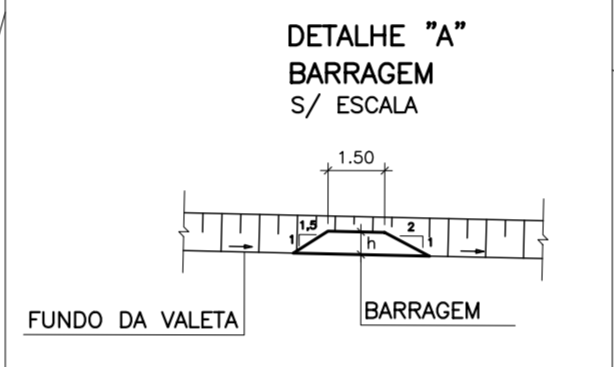
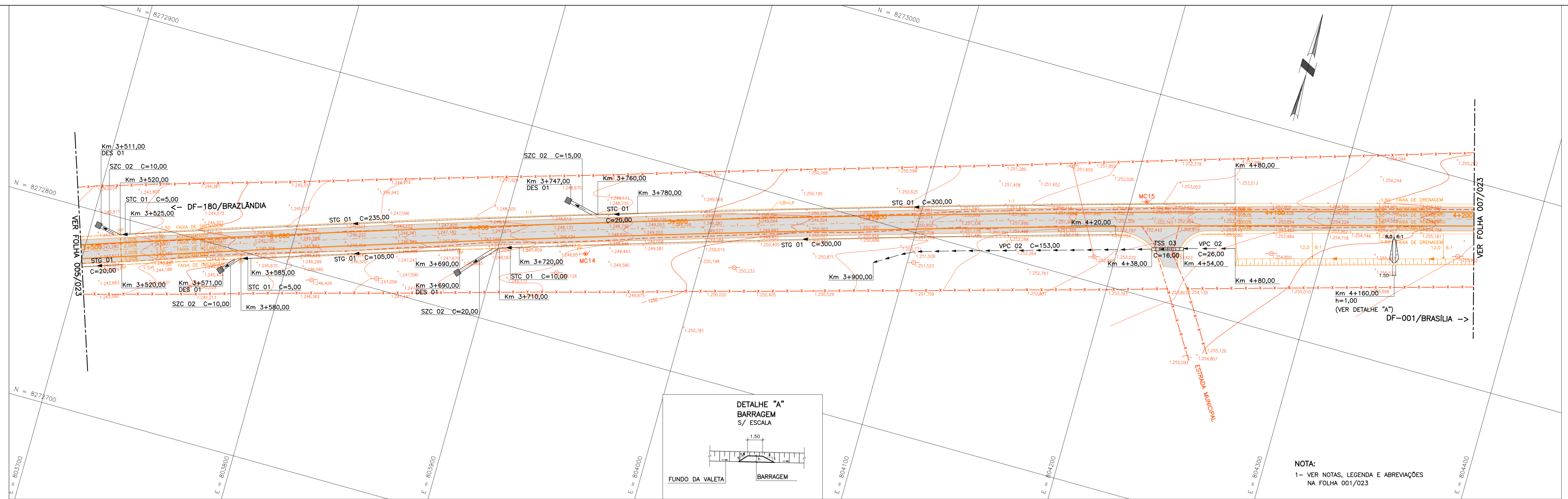

NOTA:  
1- VER NOTAS, LEGENDA E ABREVIACOES  
NA FOLHA 001/023

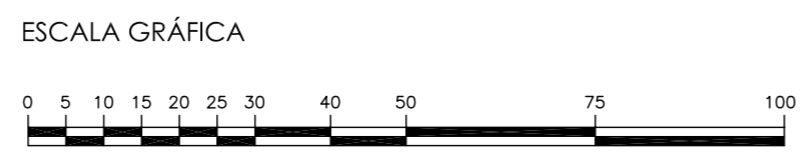
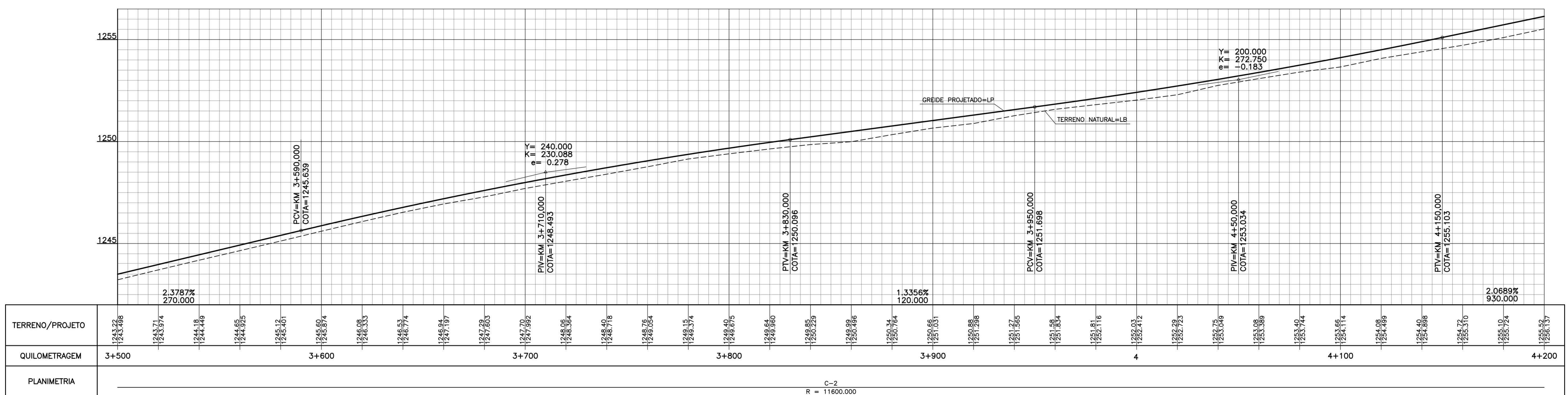

ASTEC Engenharia S/C Ltda.

FIRMA PROJETISTA	Nº	REVISÕES	DATA VISTO	DATA APROVO
			CONTRATADA	DER-DF

GDF - SO - DEPARTAMENTO DE ESTRADAS DE RODAGEM DO DISTRITO FEDERAL

TRILHO/ESPECIFICAÇÃO DO DOCUMENTO  
DF-220 PLANTA

ETAPA DE PROJETO EXECUTIVO	LOCAL DF-220	PROJETO
ESCALA A1 - H=1:1000 V=1:100 A3 - H=1:2000 V=1:200	TRECHO/SUBTRECHO Km 0 AO Km 15,9	CÁLCULO
FOLHA 006/023	ESPECIFICADA/SUBESPECIFICADA DRENAGEM SUPERFICIAL	DESENHO
REVISÃO 0	CÓDIGO	DATA AGOSTO/2004

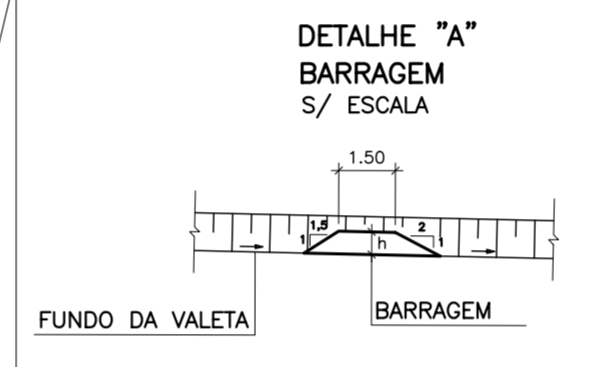
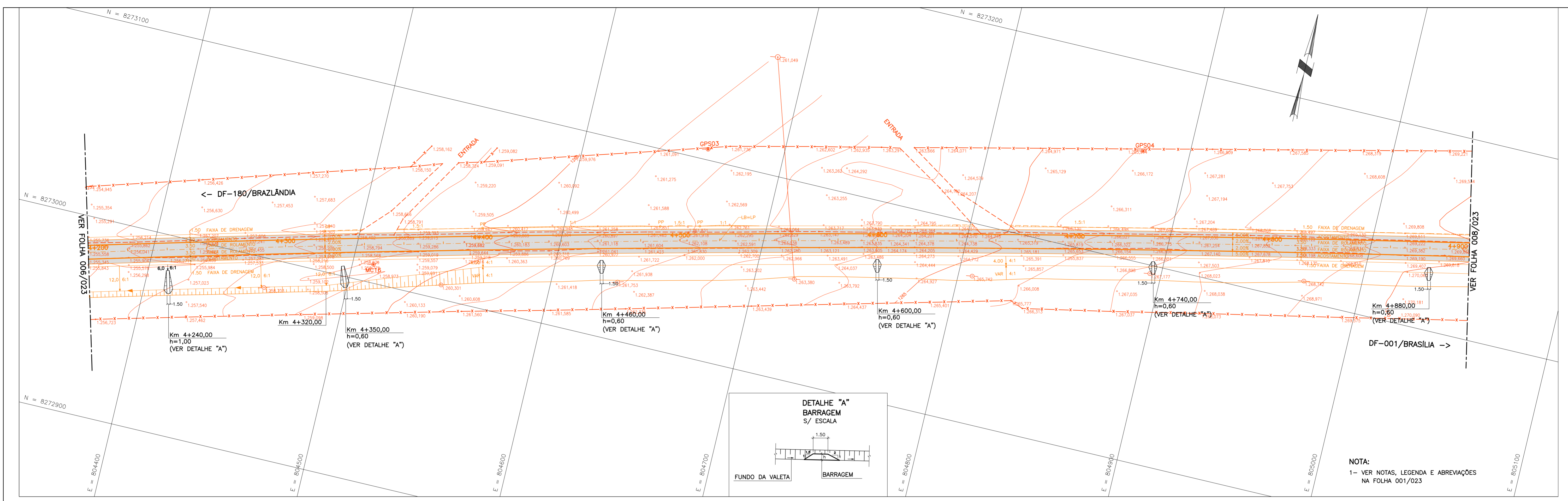

NOTA:  
1- VER NOTAS, LEGENDA E ABREVIACOES NA FOLHA 001/023

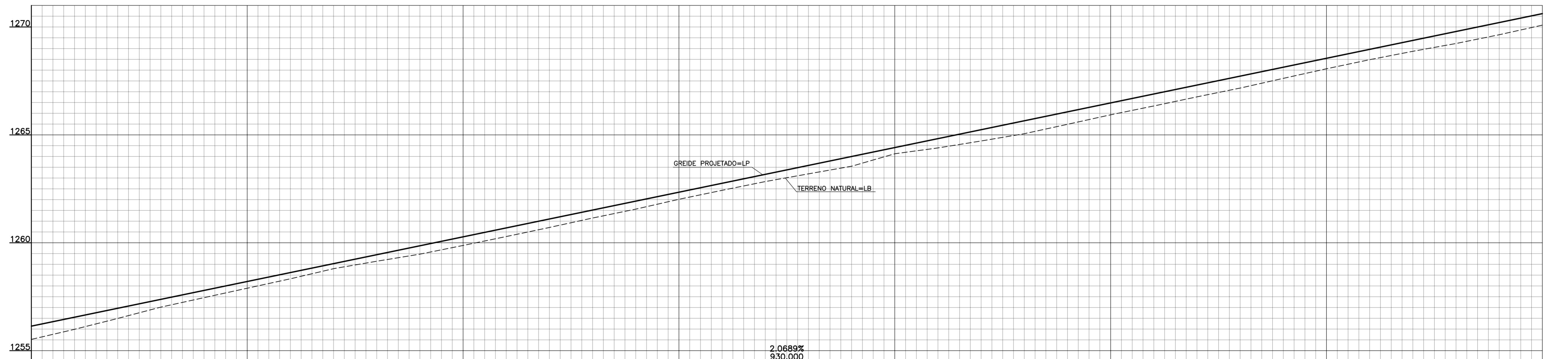

TERRENO/PROJETO	1255,87 1256,137	1255,89 1256,551	1256,49 1256,965	1257,07 1257,379	1257,46 1257,792	1257,88 1258,206	1258,33 1258,620	1258,80 1259,034	1259,44 1259,447	1259,47 1259,861	1259,88 1260,275	1260,28 1260,669	1260,71 1261,105	1261,15 1261,516	1261,56 1261,936	1262,01 1262,344	1262,43 1262,758	1262,84 1263,171	1263,19 1263,585	1263,55 1263,969	1264,13 1264,415	1264,40 1264,626	1264,72 1265,240	1265,05 1265,654	1265,49 1266,068	1265,81 1266,482	1266,34 1266,685	1266,76 1267,309	1267,17 1267,723	1267,62 1268,137	1268,06 1268,550	1268,48 1268,964	1268,87 1269,378	1269,24 1269,792	1269,56 1270,226	1270,08 1270,619			
QUILOMETRAGEM	4+200					4+300					4+400				4+500						4+600						4+700						4+800				4+900		
PLANIMETRIA	_____																																						

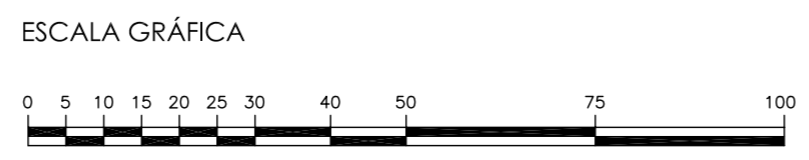

FIRMA PROJETISTA

Nº

REVISOES

DATA	VISTO	DATA	APROVO
CONTRATADA		DER-DF	

GDF - SO - DEPARTAMENTO DE ESTRADAS DE RODAGEM DO DISTRITO FEDERAL



TITULO/ESPECIFICACAO DO DOCUMENTO  
DF-220  
PLANTA

ETAPA DE PROJETO	LOCAL	PROJETO
EXECUTIVO	DF-220	
ESCALA	TRECHO/SUBTRECHO	CALCULO
A1 - H=1:1000 V=1:100	Km 0 AO Km 15,9	
A3 - H=1:2000 V=1:200		DESENHO
FOLHA	ESPECIFICACAO/SUBESPECIFICACAO	
007/023	DRENAGEM SUPERFICIAL	
REVISAO	CODIGO	DATA
0		AGOSTO/2004

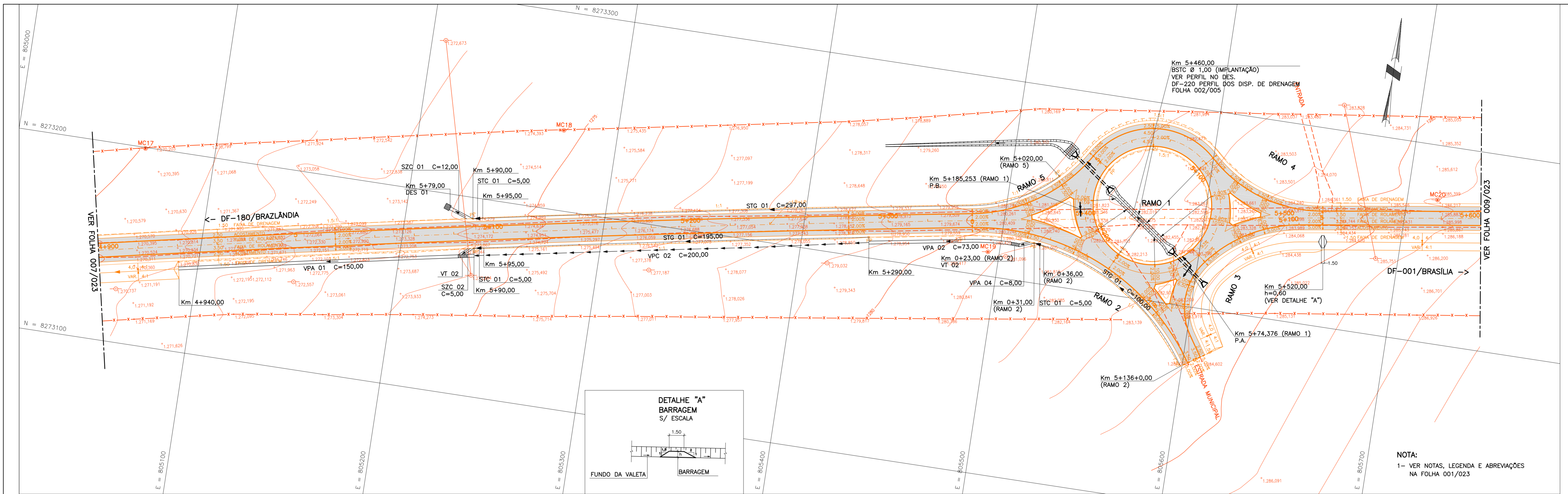

NOTA:  
1- VER NOTAS, LEGENDA E ABREVIACOES NA FOLHA 001/023

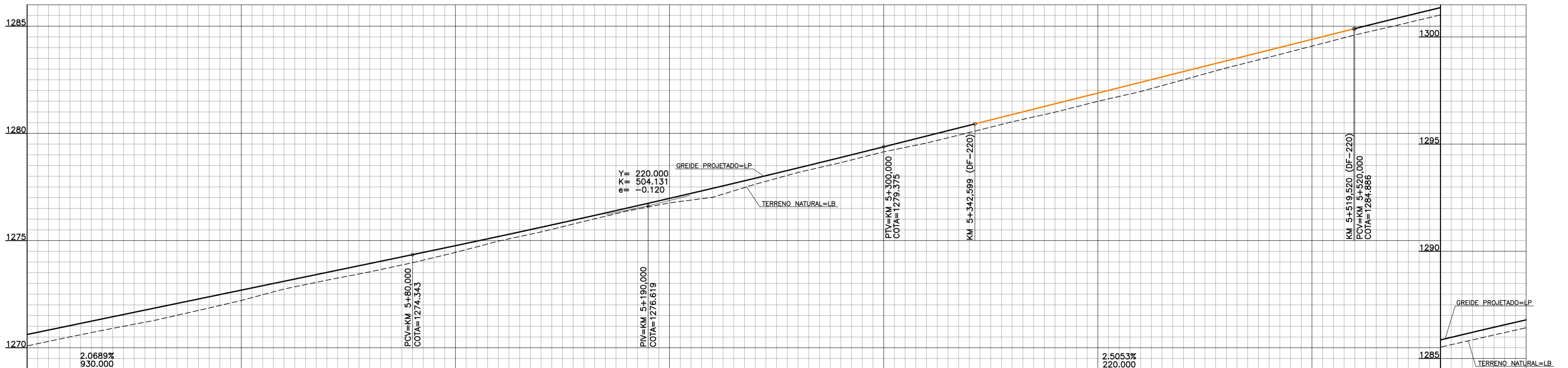

TERRENO/PROJETO	1270.69 1270.619	1270.51 1271.033	1270.81 1271.447	1271.68 1271.881	1271.74 1272.174	1272.21 1272.886	1272.74 1273.102	1273.15 1273.516	1273.54 1273.929	1273.97 1274.343	1274.45 1274.761	1274.87 1275.187	1275.40 1275.620	1275.89 1276.062	1276.37 1276.511	1276.76 1276.969	1277.02 1277.434	1277.63 1277.907	1278.18 1278.389	1278.64 1278.878	1279.14 1279.375	1279.55 1279.876	1280.04 1280.377	1280.54 1280.876	1280.99 1281.379	1281.50 1281.880	1281.95 1282.361	1282.50 1282.882	1283.05 1283.383	1283.55 1283.884	1284.07 1284.365	1284.56 1284.866	1285.05 1285.382	1285.53 1285.866	1286.08 1286.339	1286.43 1286.800							
QUILOMETRAGEM	4+900				5					5+100					5+200						5+300			5+400													5+500						5+600
PLANIMETRIA																																											



FIRMA PROJETISTA

Nº

REVISÕES

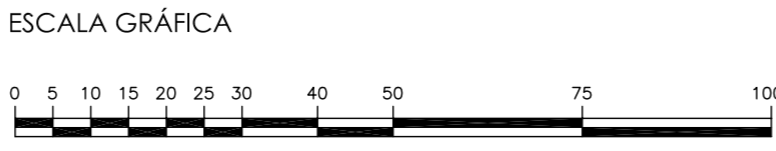

GDF - SO - DEPARTAMENTO DE ESTRADAS DE RODAGEM DO DISTRITO FEDERAL



DF-220  
PLANTA

ETAPA DE PROJETO	EXECUTIVO	LOCAL	DF-220	PROJETO
ESCALA	A1 - H=1:1000 V=1:100 A3 - H=1:2000 V=1:200	TRECHO/SUBTRECHO	Km 0 AO Km 15,9	CALCULO
FOLHA	008/023	ESPECIFICIDADE/SUBESPECIFICIDADE	DRENAGEM SUPERFICIAL	DESENHO
REVISAO	0	CODIGO		DATA
				AGOSTO/2004

DATA	VISTO	DATA	APROVO
CONTRATADA	DER-DF		





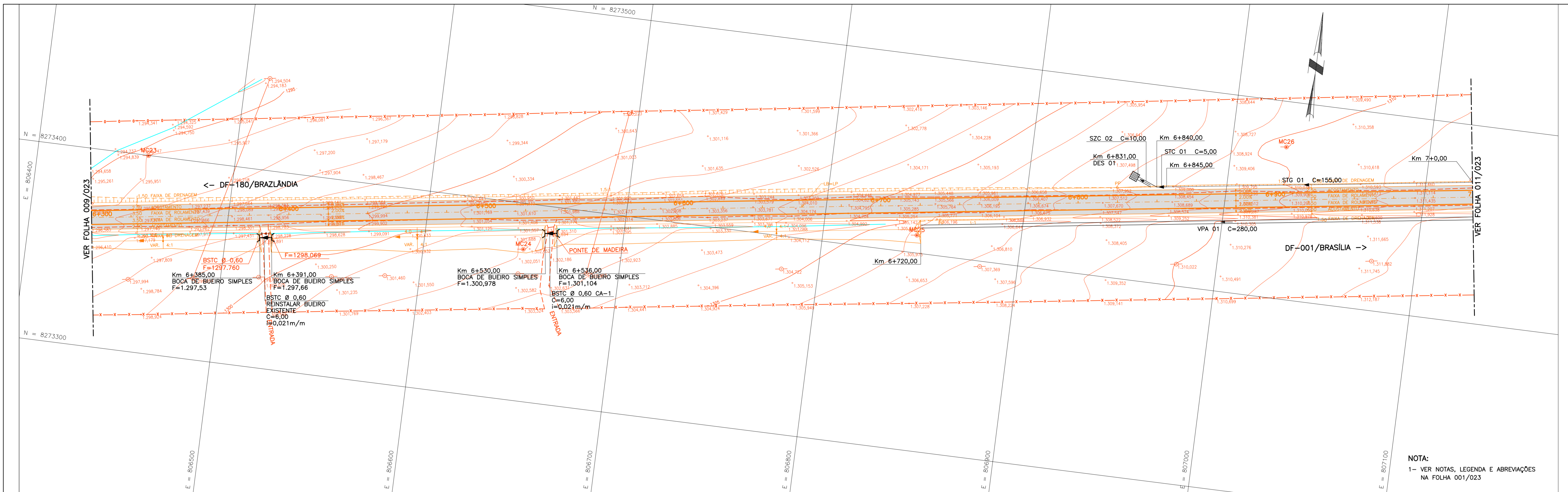

NOTA:  
1- VER NOTAS, LEGENDA E ABREVIACOES NA FOLHA 001/023

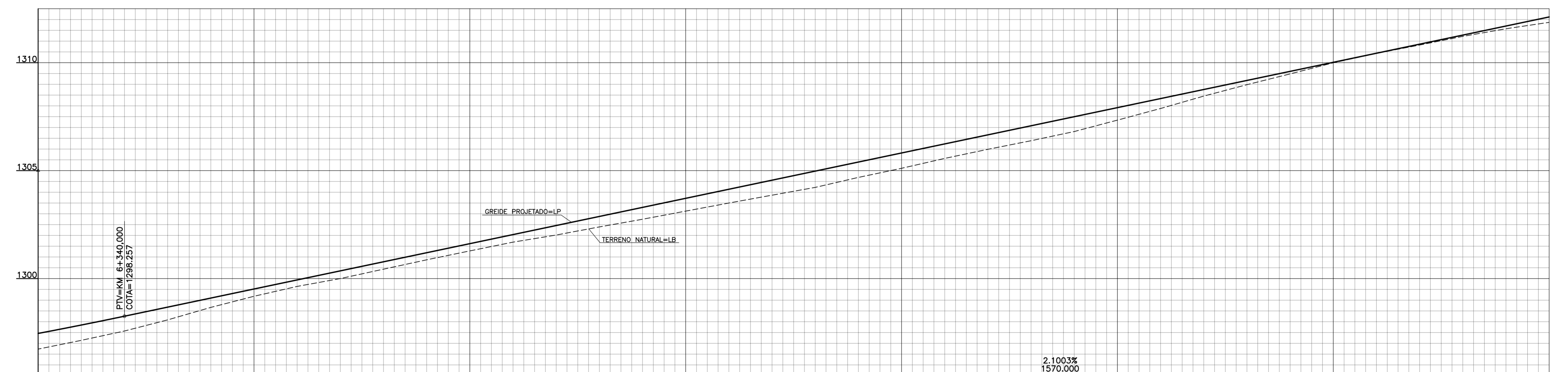

TERRENO/PROJETO	1296,73 1297,460	1297,148	1297,57 1298,257	1298,09 1298,677	1298,66 1299,097	1299,18 1299,517	1299,64 1299,637	1300,00 1300,358	1300,44 1300,778	1300,87 1301,198	1301,26 1301,616	1301,69 1302,038	1302,02 1302,468	1302,39 1302,878	1302,75 1303,298	1303,17 1303,778	1303,50 1304,138	1303,86 1304,558	1304,27 1304,978	1304,69 1305,398	1305,11 1305,818	1305,52 1306,238	1305,99 1306,698	1306,39 1307,078	1306,81 1307,498	1307,34 1307,919	1307,88 1308,519	1308,49 1309,179	1308,98 1309,679	1309,48 1310,199	1310,00 1310,439	1310,43 1310,869	1310,86 1311,229	1311,27 1311,669	1311,67 1312,119				
QUILOMETRAGEM	6+300		6+400							6+500					6+600					6+700						6+800					6+900						7		
PLANIMETRIA	TANGENTE L = 5452,6349																																						

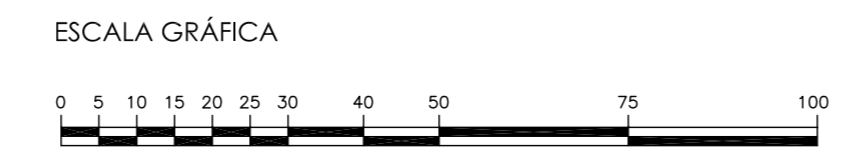

ASTEC  
Engenharia S/C Ltda.

FIRMA PROJETISTA	Nº	REVISOES	DATA	VISTO	DATA	APROVO
			CONTRATADA	DER-DF		

DER - SO - DEPARTAMENTO DE ESTRADAS DE RODAGEM DO DISTRITO FEDERAL

TRILHO/ESPECIFICACAO DO DOCUMENTO

DF-220  
PLANTA

ETAPA DE PROJETO	LOCAL	PROJETO
EXECUTIVO	DF-220	
ESCALA	TRECHO/SUBTRECHO	CALCULO
A1 - H=1:1000 V=1:100	Km 0 AO Km 15,9	
A3 - H=1:2000 V=1:200	ESPECIFICACAO/SUBESPECIFICACAO	DESENHO
FOLHA	010/023	
REVISAO	0	DATA
		AGOSTO/2004



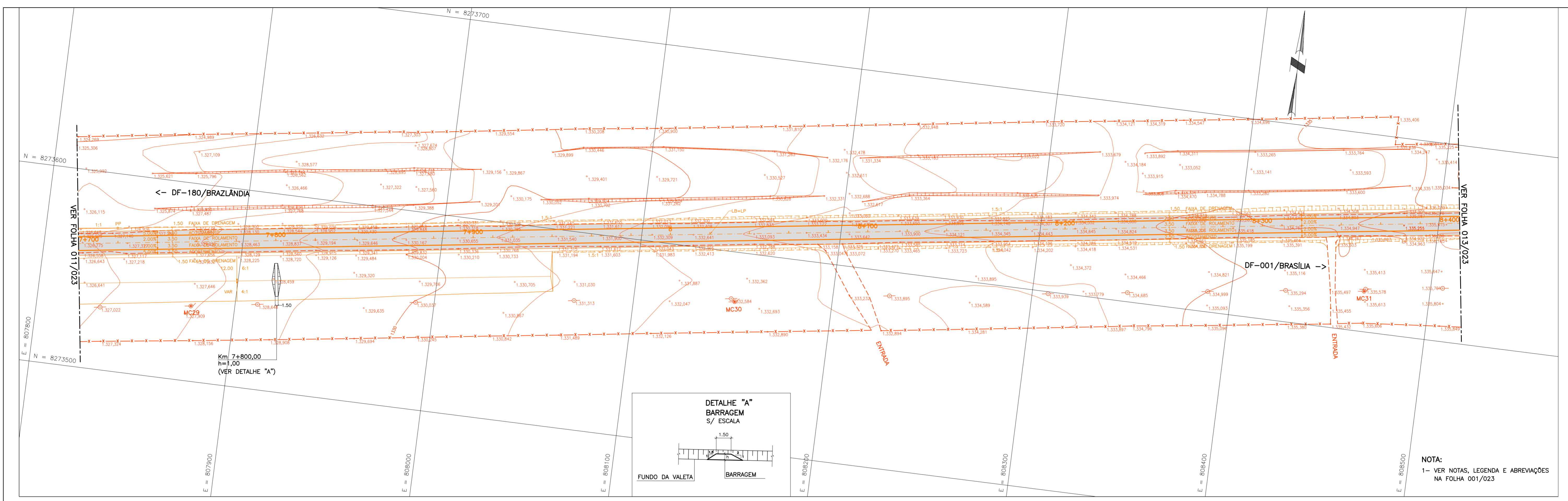

NOTA:  
1- VER NOTAS, LEGENDA E ABREVIACOES NA FOLHA 001/023

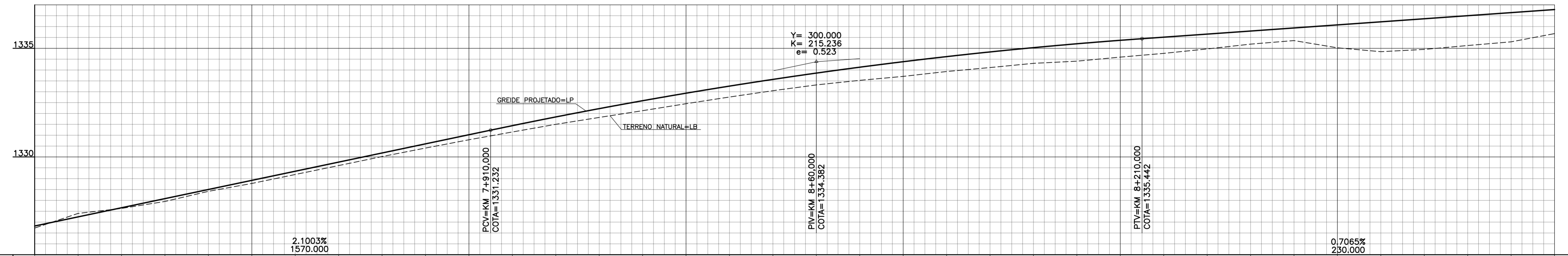

TERRENO/PROJETO	1326,723 1326,821	1327,40 1327,241	1327,68 1327,681	1327,95 1328,081	1328,42 1328,501	1328,78 1328,821	1329,19 1329,341	1329,60 1329,781	1330,06 1330,181	1330,41 1330,602	1330,78 1331,022	1331,15 1331,439	1331,50 1331,841	1331,82 1332,224	1332,13 1332,588	1332,45 1332,934	1332,78 1333,281	1333,05 1333,589	1333,32 1333,859	1333,53 1334,101	1333,71 1334,383	1333,93 1334,618	1334,13 1334,835	1334,31 1335,030	1334,41 1335,269	1334,58 1335,589	1334,77 1335,512	1334,87 1335,654	1335,19 1335,795	1335,36 1335,936	1335,62 1336,077	1336,04 1336,219	1336,45 1336,580	1336,81 1336,901	1337,00 1337,241				
QUILOMETRAGEM	7+700				7+800					7+900				8						8+100					8+200							8+300					8+400		
PLANIMETRIA	TANGENTE L= 5452,6349																																						

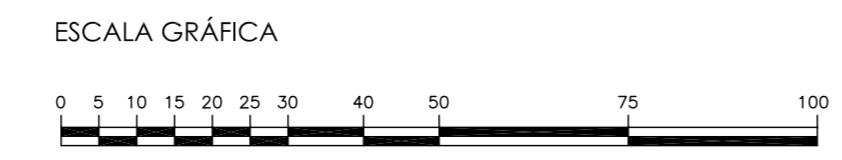

ASTEC  
Engenharia S/C Ltda.

ESCALA GRAFICA

FIRMA PROJETISTA Nº REVISÕES

DATA VISTO DATA APROVO

CONTRATADA DER-DF

DER - SO - DEPARTAMENTO DE ESTRADAS DE RODAGEM DO DISTRITO FEDERAL

TÍTULO/ESPECIFICAÇÃO DO DOCUMENTO

**DF-220**  
PLANTA

ETAPA DE PROJETO EXECUTIVO LOCAL DF-220

ESCALA: A1 - H=1:1000 V=1:100 RECHÃO/SUBRECHÃO Km 0 AO Km 15,9 CÁLCULO

FOLHA 012/023 ESPECIFICADA/SUBESPECIFICADA DRENAGEM SUPERFICIAL DESENHO

REVISÃO 0 CÓDIGO DATA AGOSTO/2004















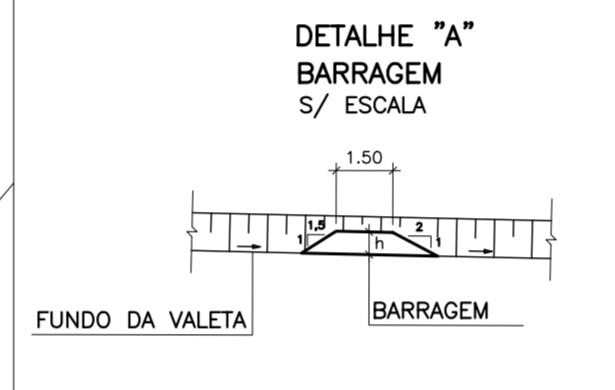
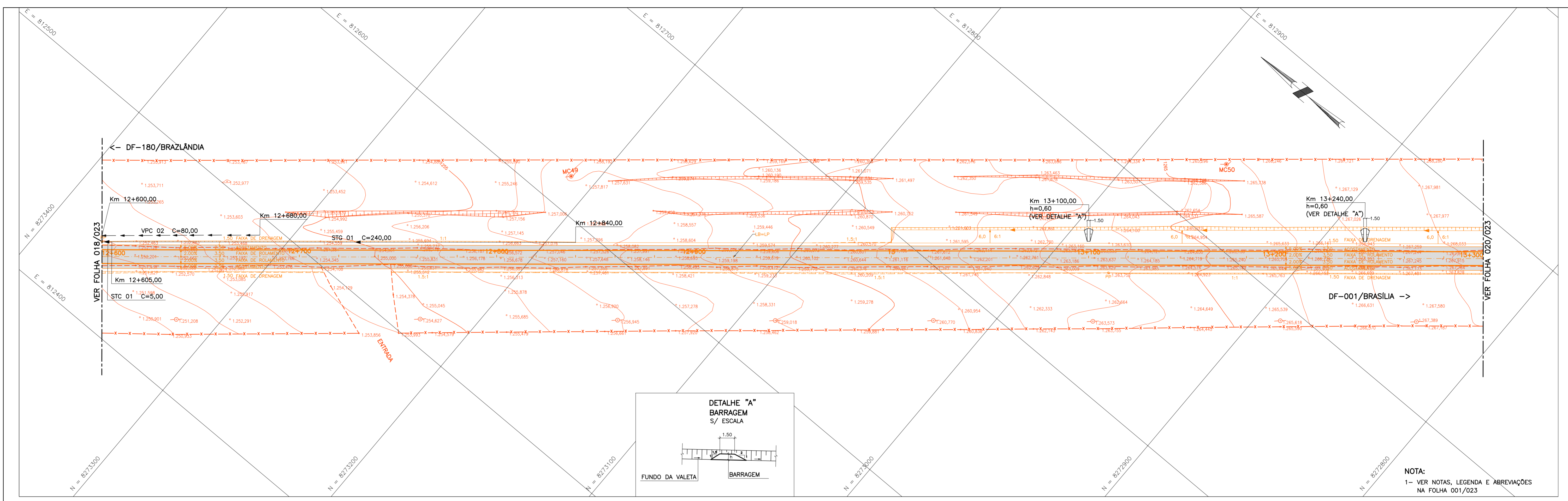

NOTA:  
1- VER NOTAS, LEGENDA E ABREVIACOES NA FOLHA 001/023

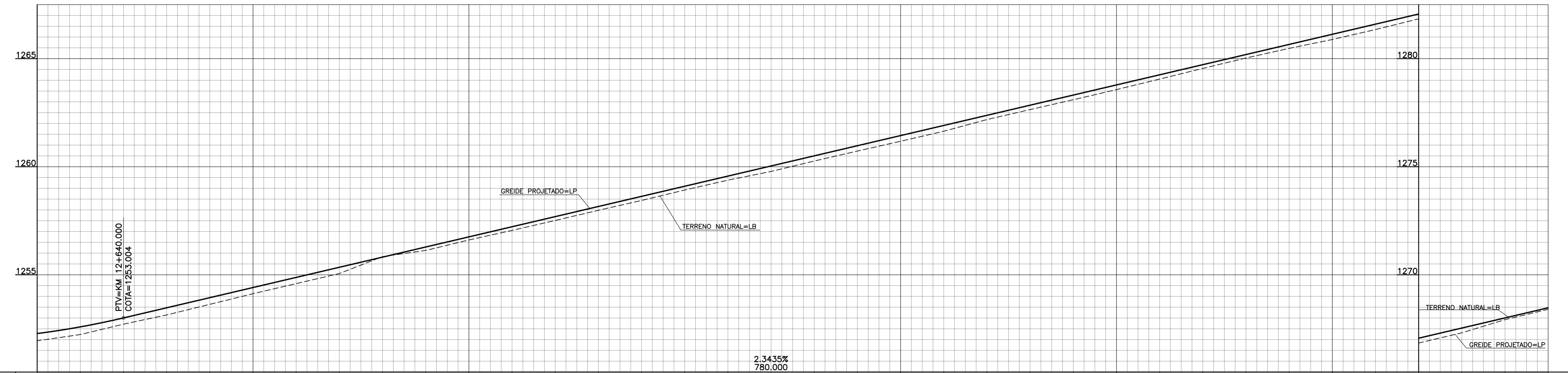

TERRENO/PROJETO	1251,94 1252,281	1252,83 1252,689	1252,71 1253,004	1253,14 1253,472	1253,63 1253,961	1254,12 1254,410	1254,59 1254,879	1255,06 1255,347	1255,84 1255,816	1256,13 1256,285	1256,61 1256,735	1257,05 1257,222	1257,51 1257,691	1257,88 1258,160	1258,44 1258,628	1258,82 1259,097	1259,39 1259,566	1259,78 1260,034	1260,36 1260,605	1260,72 1260,972	1261,18 1261,441	1261,64 1261,809	1262,18 1262,378	1262,84 1262,847	1263,10 1263,315	1263,57 1263,784	1264,05 1264,263	1264,49 1264,721	1265,03 1265,190	1265,48 1265,659	1265,89 1266,128	1266,35 1266,596	1266,84 1267,065	1267,31 1267,534	1267,92 1268,002	1268,40 1268,471	
QUILOMETRAGEM	12+600			12+700						12+800					12+900					13				13+100						13+200							13+300
PLANIMETRIA	TANGENTE L= 3866,3684																																				

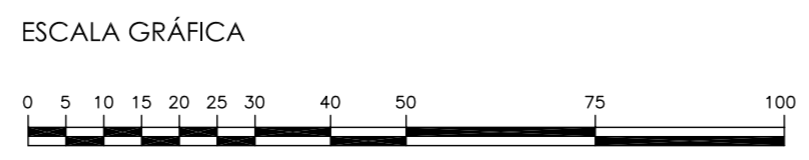

FIRMA PROJETISTA	Nº	REVISOES	DATA	VISTO	DATA	APROVO
			CONTRATADA		DER-DF	

GDF - SO - DEPARTAMENTO DE ESTRADAS DE RODAGEM DO DISTRITO FEDERAL		
TITULO/ESPECIFICACAO DO DOCUMENTO		
	DF-220 PLANTA	
ETAPA DE PROJETO EXECUTIVO	LOCAL DF-220	PROJETO
ESCALA A1 - H=1:1000 V=1:100 A3 - H=1:2000 V=1:200	TRECHO/SUBTRECHO Km 0 AO Km 15,9	CALCULO
FOLHA 019/023	ESPECIFICACAO/SUBESPECIFICACAO DRENAGEM SUPERFICIAL	DESENHO
REVISAO 0	CODIGO	DATA AGOSTO/2004

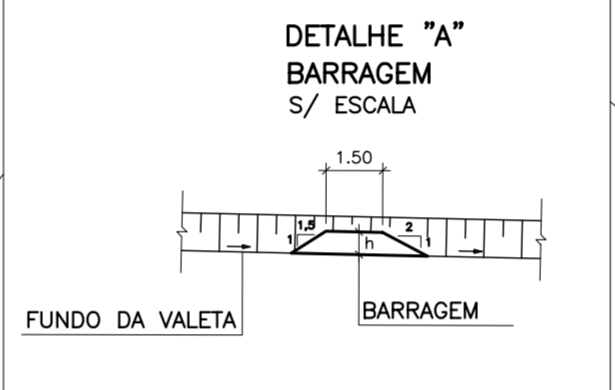
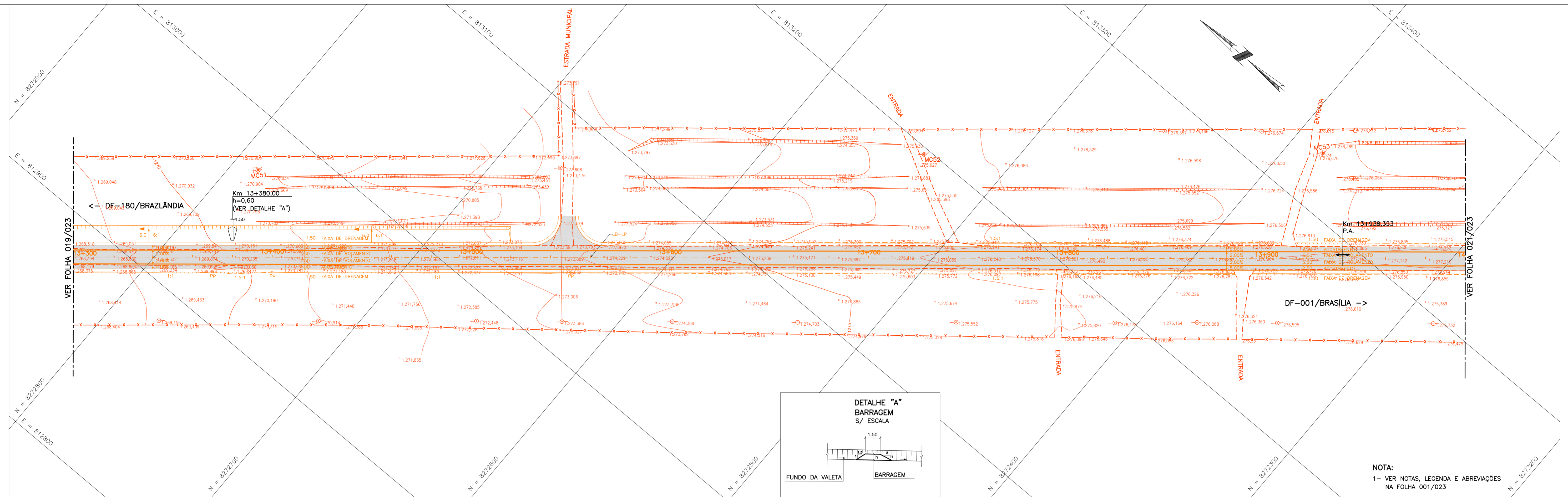

NOTA:  
1- VER NOTAS, LEGENDA E ABREVIACOES NA FOLHA 001/023

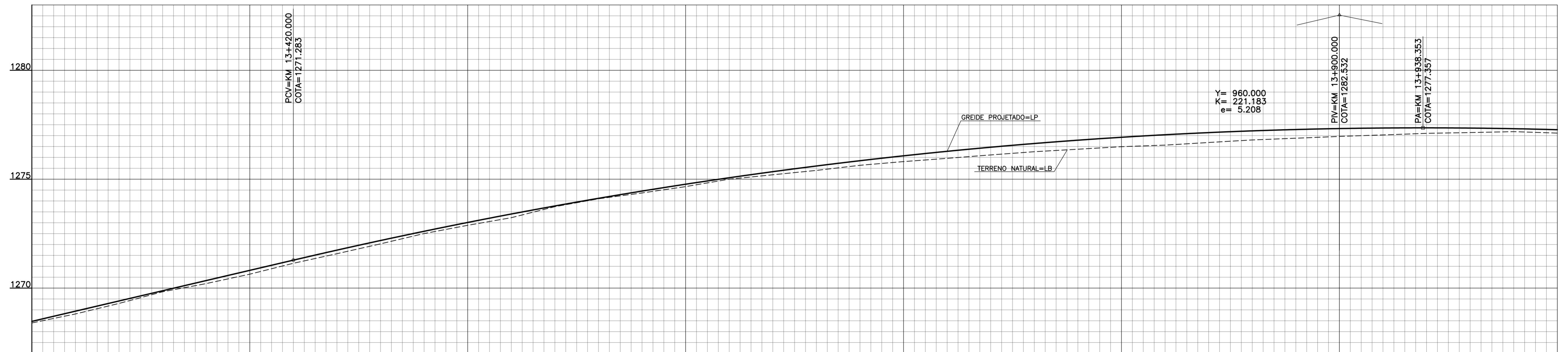

TERRENO/PROJETO	1268.40 1266.471	1268.61 1266.640	1268.30 1266.409	1268.83 1266.877	1270.21 1270.246	1270.64 1270.815	1271.14 1271.283	1271.58 1271.743	1272.03 1272.185	1272.50 1272.608	1272.88 1273.014	1273.23 1273.401	1273.74 1273.770	1274.10 1274.121	1274.37 1274.454	1274.66 1274.769	1275.08 1275.086	1275.20 1275.345	1275.40 1275.606	1275.64 1275.848	1275.81 1276.073	1275.98 1276.280	1276.11 1276.488	1276.26 1276.638	1276.38 1276.780	1276.49 1276.925	1276.56 1277.041	1276.68 1277.199	1276.80 1277.219	1276.88 1277.280	1276.96 1277.324	1277.03 1277.350	1277.11 1277.357	1277.14 1277.347	1277.18 1277.318	1277.19 1277.271	
ESTAQUEAMENTO	13+300				13+400						13+500				13+600							13+700				13+800						13+900					14
PLANIMETRIA	TANGENTE L= 3866.3684																																				

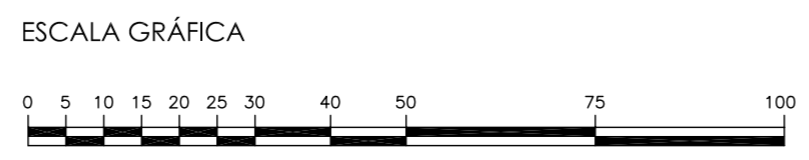

FIRMA PROJETISTA Nº

REVISÕES

DATA	VISTO	DATA	APROVO
CONTRATADA		DER-DF	

GDF - SO - DEPARTAMENTO DE ESTRADAS DE RODAGEM DO DISTRITO FEDERAL

**DER DF**

TÍTULO/ESPECIFICAÇÃO DO DOCUMENTO  
DF-220  
PLANTA

ETAPA DE PROJETO: EXECUTIVO LOCAL: DF-220 PROJETO

ESCALA: A1 - H=1:1000 V=1:100 RECHÔ/SUBRECHÔ: Km 0 AO Km 15,9 CÁLCULO

FOLHA: 020/023 ESPECIFICADA/SUBESPECIFICADA: DRENAGEM SUPERFICIAL DESENHO

REVISÃO: 0 CÓDIGO: DATA: AGOSTO/2004

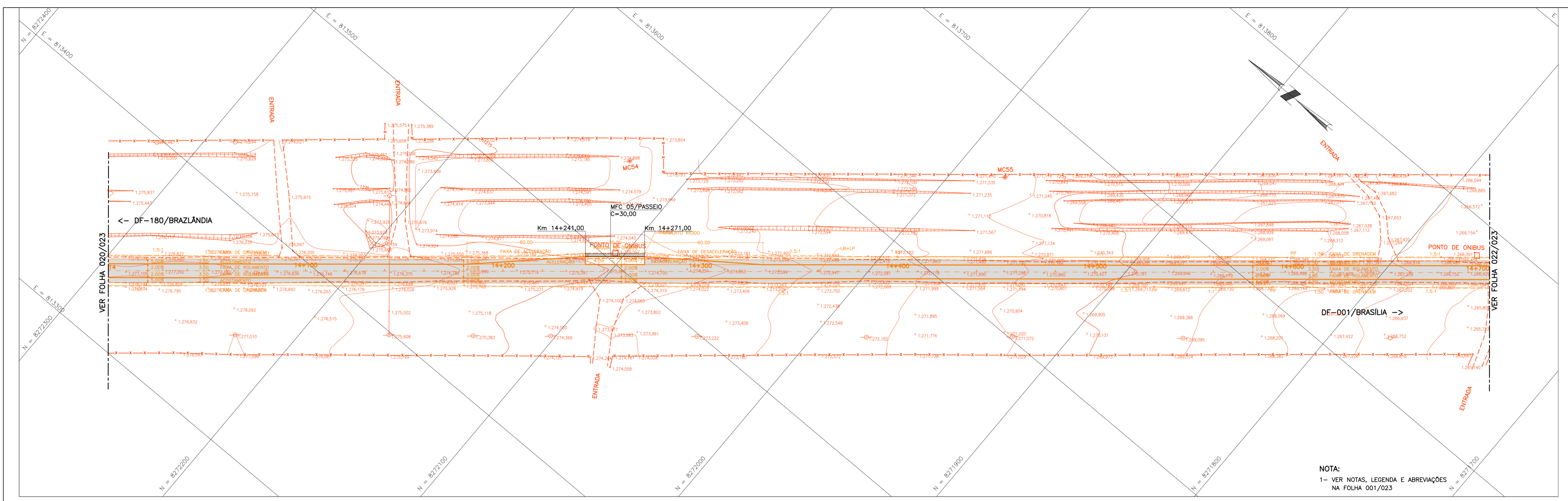

NOTA:  
1- VER NOTAS, LEGENDA E ABREVIACOES NA FOLHA 001/023

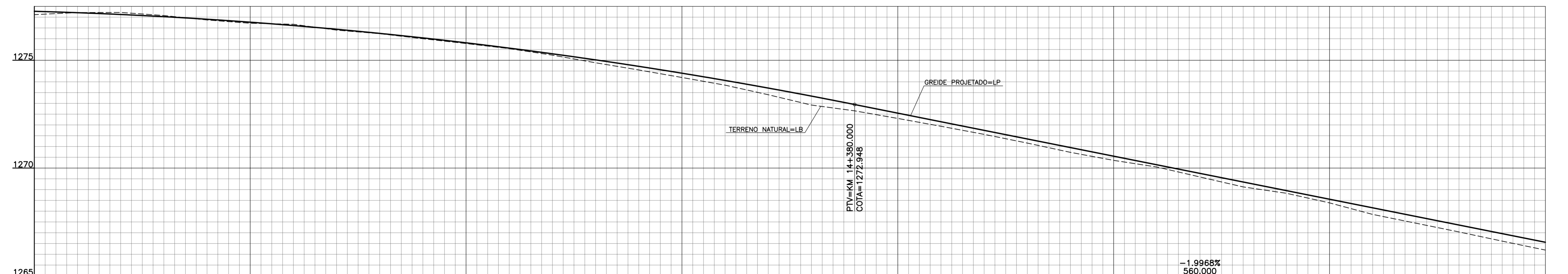

TERRENO/PROJETO	1277.12	1277.21	1277.24	1277.08	1276.87	1276.77	1276.67	1276.40	1276.27	1276.00	1275.78	1275.54	1275.24	1274.88	1274.55	1274.20	1273.85	1273.40	1272.92	1272.55	1272.30	1271.94	1271.56	1271.16	1270.73	1270.36	1270.05	1269.59	1269.13	1268.83	1268.38	1267.85	1267.44	1267.04	1266.61	1266.20			
QUILOMETRAGEM	14				14+100						14+200					14+300						14+400					14+500									14+600			14+700
PLANIMETRIA	TANGENTE L = 3866.3684																																						

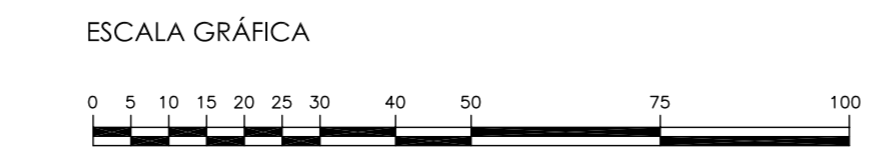

ASTEC  
Engenharia S/C Ltda.

DATA VISTO DATA APROVO

CONTRATADA DER-DF

FIRMA PROJETISTA Nº REVISÕES

GDF - SO - DEPARTAMENTO DE ESTRADAS DE RODAGEM DO DISTRITO FEDERAL

TRILHO/ESPECIFICAÇÃO DO DOCUMENTO

DF-220 PLANTA

ETAPA DE PROJETO EXECUTIVO LOCAL DF-220

ESCALA: A1 - H=1:1000 V=1:100 RECHO/SUBRECHO Km 0 AO Km 15,9

FOLHA 021/023 ESPECIFICACAO/SUBESPECIFICACAO DRENAGEM SUPERFICIAL

REVISAO 0 CÓDIGO DATA AGOSTO/2004



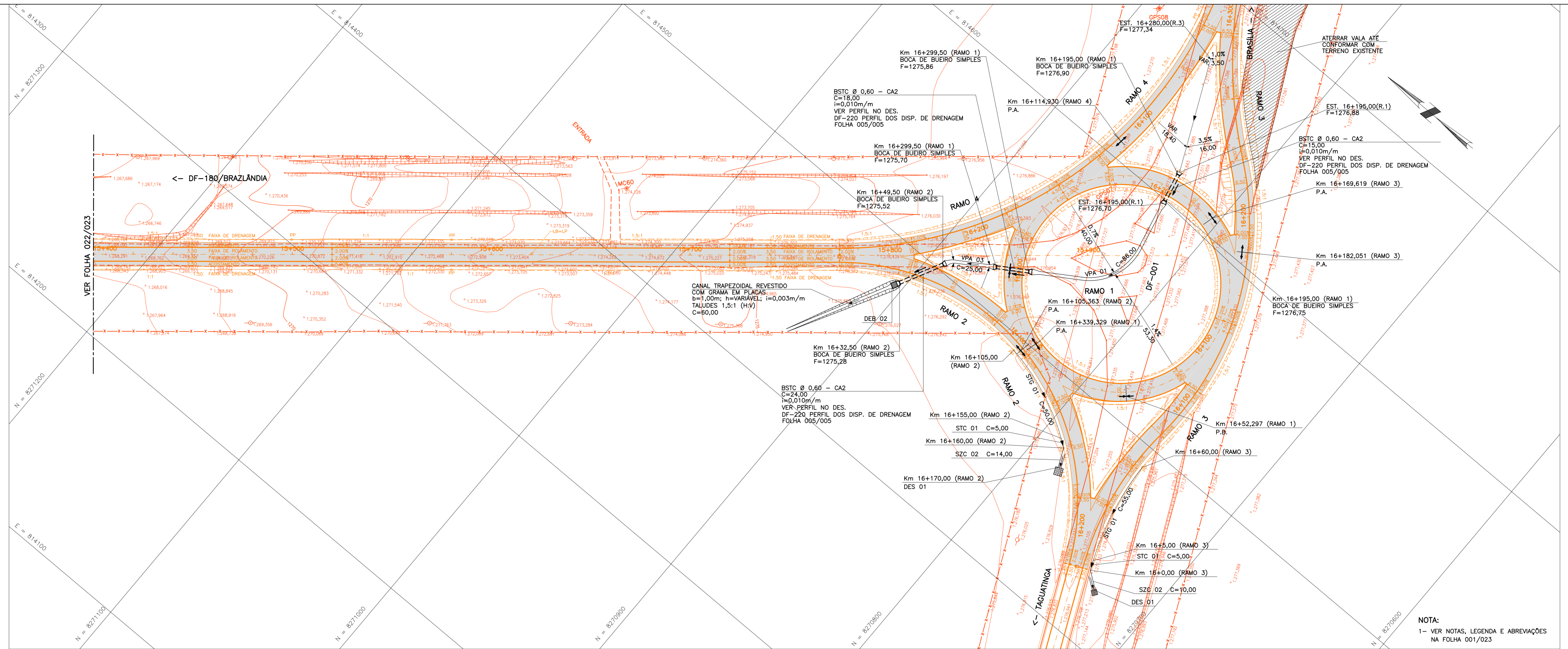

NOTA:  
1- VER NOTAS, LEGENDA E ABREVIACOES NA FOLHA 001/023

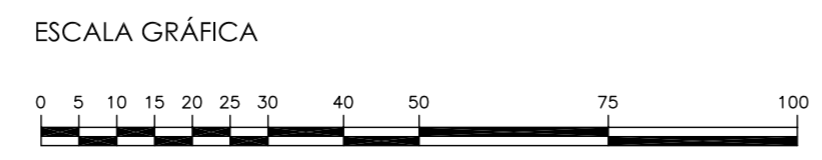
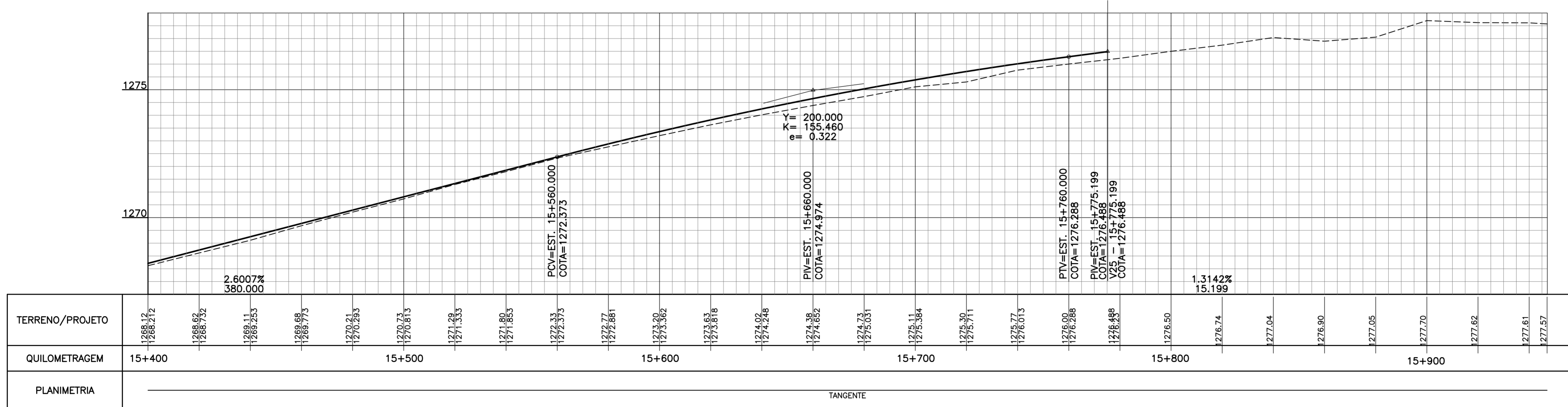

FIRMA PROJETISTA Nº REVISOES

GDF - SO - DEPARTAMENTO DE ESTRADAS DE RODAGEM DO DISTRITO FEDERAL			
DER DF		TRILHO/ESPECIFICACAO DO DOCUMENTO	
		DF-220 PLANTA	
ETAPA DE PROJETO	LOCAL	PROJETO	
EXECUTIVO	DF-220		
ESCALA: A1 - H=1:1000 V=1:100	RECHOS/SUBRECHOS	CALCULO	
A3 - H=1:2000 V=1:200	Km 0 AO Km 15,9		
FOLHA	ESPECIFICACAO/SUBESPECIFICACAO	DESENHO	
023/023	DRENAGEM SUPERFICIAL		
REVISAO	CODIGO	DATA	
0		AGOSTO/2004	